



- Thank you for purchasing our product. This product is a multifunction meter and is easy to install. Before using, read the instructions carefully and retain them for future reference.

⚠ Attention!

- For installation, follow the steps described. Any damage caused by wrong installation shall be imputed to the users.
- To avoid a short circuit from occurring do not pull or modify the wires during installation.
- Do not disassemble or change any parts. Opening and disassembling this unit will void any warranty.
- Maintenance and repairs should be executed by our professionals only.

⊙ Symbol description:

NOTE

⚠ Some procedures must be followed to avoid damages to the instrument.

⚠ **WARNING!** Certain procedure must be followed to avoid damages to yourself, to the vehicle or others.

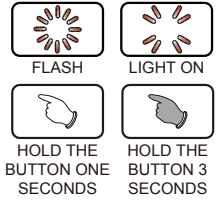

1 Accessories

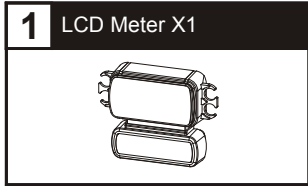

2-1 Wiring Installation Instructions

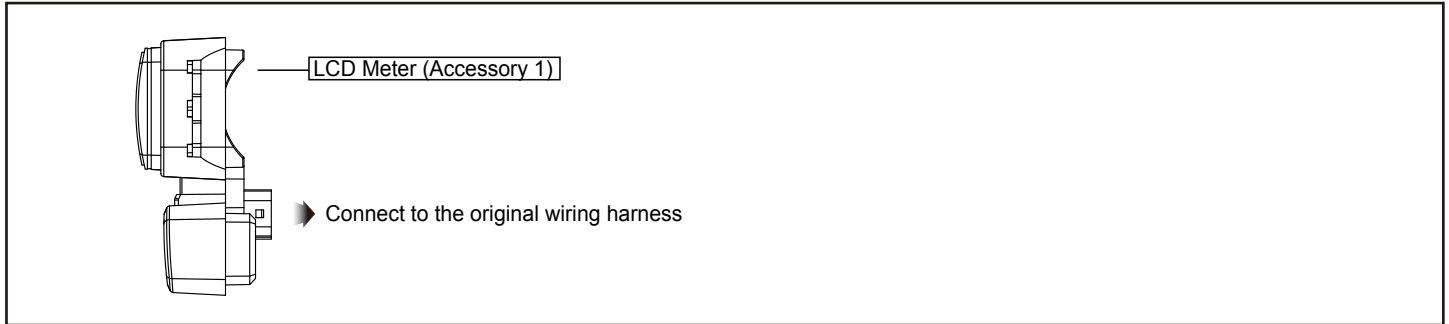

2-2 Vehicle installation instructions

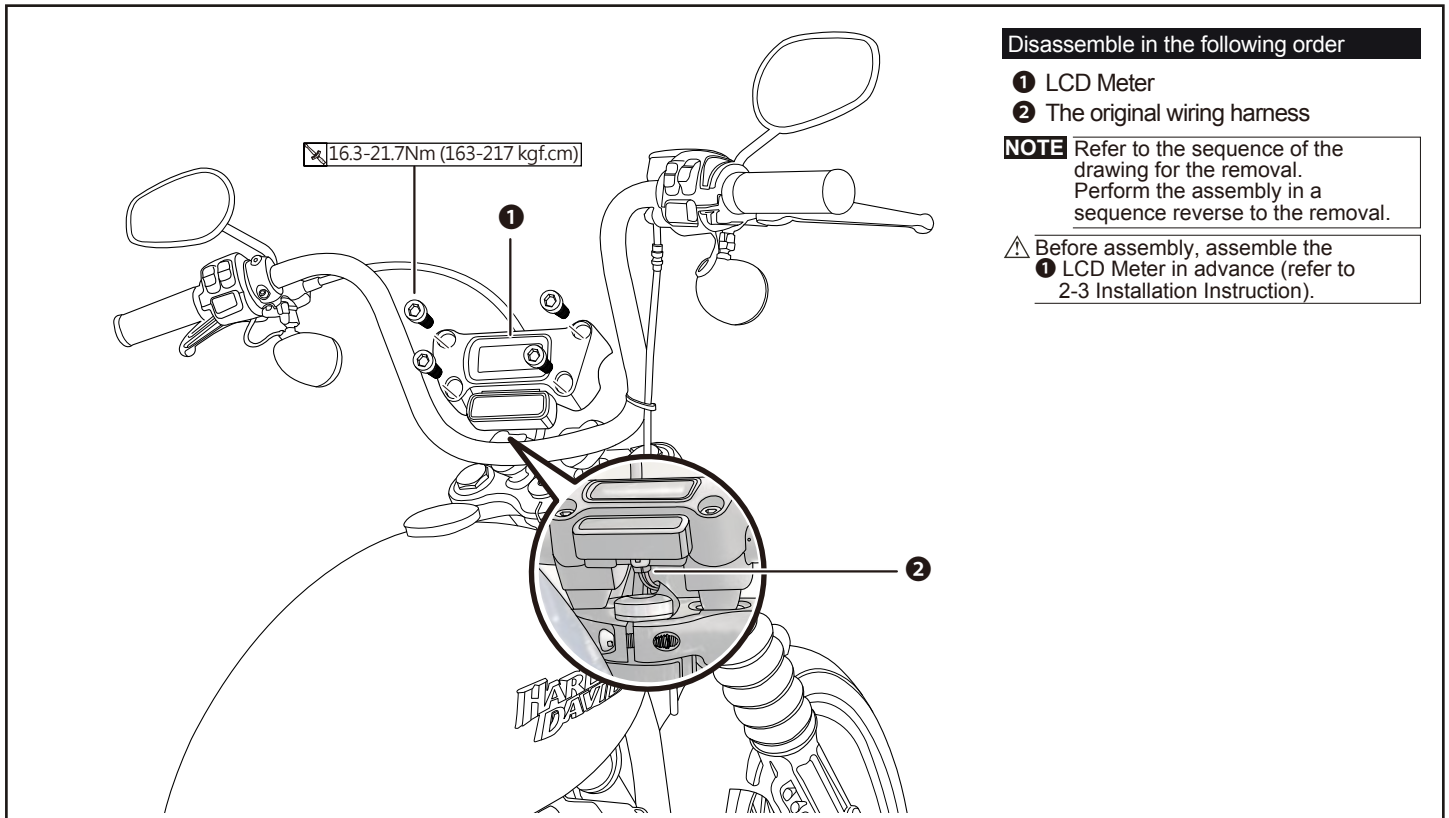

Disassemble in the following order

- 1 LCD Meter
- 2 The original wiring harness

NOTE Refer to the sequence of the drawing for the removal. Perform the assembly in a sequence reverse to the removal.

⚠ Before assembly, assemble the 1 LCD Meter in advance (refer to 2-3 Installation Instruction).

2-3 Installation instructions

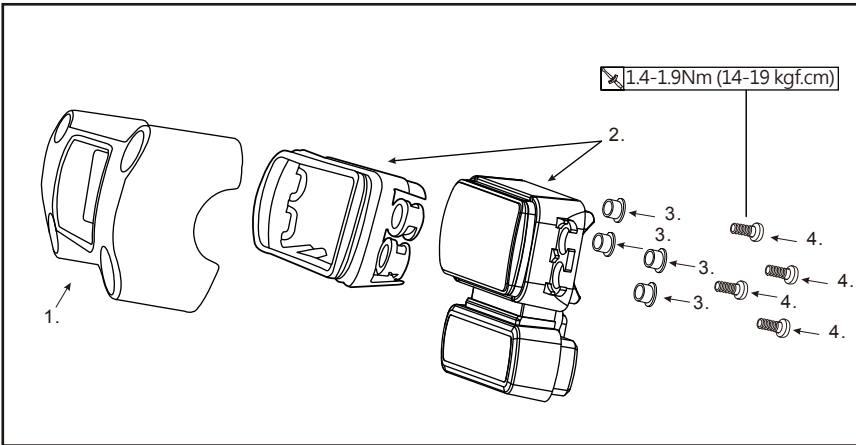

Follow the steps below

1. Meter bracket (from original supplier)
2. Waterproof outer lining (from original supplier)
+LCD Meter (Accessory1)
3. Bushing (from original supplier)
4. Screw (from original supplier)

3-1 Overview

Tachometer

- Display range : 0 ~ 10,000 RPM

Speedometer

- Display range : 0~199 km (0~124 miles)
- Display unit : 1 km (mile)

Indicator

- Right indication light (Green)
- Security light (Red)
- ABS light (Amber)
- Motor oil light (Red)
- Neutral light (Green)
- High beam light (Blue)
- Low fuel warning light (Amber)
- Left indication light (Green)
- Fog light (Green)
- Battery discharge light (Red)
- Engine light (Amber)
- Cruise light (Green/Amber)
- Tire pressure warning light (Amber)

Fuel meter

- Display range : 10 Levels

Mileage maintenance user settings (closable)

- Display range : user adjustable (500 ~ 16,000 km / 300 ~ 10,000 miles) ~ -999 km (miles), automatic decrease according to the increase of total mileage.
- Display unit : 1 km (mile)

Remaining mileage

- Display range : 0 ~ 999 km (625 mile), "r Lo" shall be displayed when the mileage is too low.

Tire pressure (TPMS, FR/RR/LR shall be displayed when the vehicle supports TPMS)

- Display range : ---, Hi, 0~73 PSI, 0~506 kPa, 0.0~5.0 bar
- Display unit : 1 PSI, 1 kPa, 0.1 bar

Time

- Display range : 12 / 24 hour format

Engine temperature

- Display range : -39 ~ 300 °C (-38 ~ 572 °F)

Voltmeter

- Display range : 8 ~ 18 V

Odometer

- Display range : 0 ~ 999,999 km (miles) return to zero upon exceeding
- Display unit : 1 km (mile)

Distance meter A,B

- Display range : 0 ~ 9,999.9 km (miles) return to zero upon exceeding
- Display unit : 0.1 km (mile)

3-2 Features and settings description

●Speedometer	Display range : 0~199 km (0~124 mile) switchable Display unit : 1 km (mile)	●Tire pressure	(TPMS, FR/RR/LR shall be displayed when the vehicle supports TPMS) Display range : ---, Hi, 0~73 PSI, 0~506 kPa, 0.0~5.0 bar Display unit : 1 PSI, 1 kPa, 0.1 bar
○Display interval	<0.5 second	●Fuel meter	Display range : 10 levels
○Internal and external odometer	Display range : 000,000~999,999 km (mile) returns to zero upon exceeding Display unit : 1 km (mile)	●Operating voltage	DC 12 V
○Trip meter A,B	Display range : 0,000.0~9,999.9 km (mile) returns to zero upon exceeding Display unit : 0.1 km (mile)	●Operating temperature	-20~85 °C
○Tire circumference	Setting range : 50 ~ 210 % Setting unit : 1 %	○Storage temperature	-30~90 °C
●Tachometer	Display range : 0 ~ 10,000 RPM	●Specifications	JIS D 0203 (S2)
○Shift light warning	Setting range : 2,000 ~ 10,000 RPM When it is higher than the setting value (including), the backlight will blink in red and white as a warning. Setting unit : 100 RPM	●Meter size	88.2 x 67.0 x 35.2 mm
●Engine temperature	Setting range : -39 ~ 300 °C (-38 ~ 572 °F)	●Meter weight	Around 70 g
●Clock	Setting range : 12 / 24 hour format	●Indication light	Right indication light (Green) → Security light (Red) ● ABS light (Amber) ⊙ Motor oil light (Red) ⚡ Neutral light (Green) N High beam light (Blue) ⚡ Low fuel warning light (Amber) ⛽ Left indication light (Green) ← Fog light (Green) ⚡ Battery discharge light (Red) 🔋 Engine light (Amber) ⚡ Cruise light (Green/Amber) 🚗 Tire pressure warning light (Amber) ⚠
●Voltmeter	Display range : 8 ~ 18 V		
●Backlight brightness	Setting range : 1 / 5 (darkest) ~ 5 / 5 (brightest)		
○Backlight color	Setting range : white, red, orange, yellow, green, blue, light blue, purple		
●Mileage maintenance	Setting range : Off, 500 ~ 16,000 km (300 ~ 10,000 mile) Setting unit : 100 km (miles)		

NOTE Design and specification may change without further notice.

3-3 Main menu functions

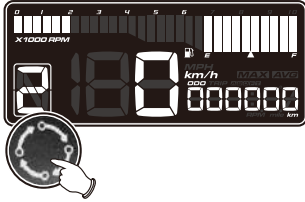

- In the total mileage screen, press the **button once** to switch to Trip A screen.
- In the total mileage screen, hold the **button for 3 seconds** to enter into the setting screen. (refer to setting 4)



- Trip A screen, press the **button once** to switch to Trip B screen.
- Hold the **button for 3 seconds** to clear the Trip A recordings.



- Trip B screen, press the **button once** to switch to the mileage maintenance screen.
- Hold the **button for 3 seconds** to clear the Trip B recordings.



NOTE Display can be switched off (refer to setting 4-6-1)



- In the mileage maintenance screen, press the **button once** to switch to the remaining mileage screen.

- Mileage maintenance will count down from setting value, when it reaches 0, the screen will blink to indicate mileage reached.



- When the reminding feature is activated, it will automatically return to the mileage maintenance screen once the mileage maintenance value is reached.



- Hold the **button for 3 seconds** to switch to inform function switch.



NOTE It will not display if it's not supported by the engine computer.

- Hold the **button for 10 seconds** to clear the mileage maintenance recordings.



- At 0 seconds, start holding the button.



- In the 3rd second, the inform feature will blink once.



- In the 5th second, inform feature will switch back, mileage display will begin blinking.



- During the 6~9th seconds, if the button is released, it will cancel the process.



- On the 10th second, the mileage maintenance record is cleared.

NOTE Display can be switch off (refer to setting 4-7)



- In the remaining mileage screen, press the **button once** to switch to the clock screen.

- When the vehicle range is too low, "r Lo" it will be displayed to notify the user.



- When the reminding feature is activated, it will automatically return to the remaining screen, if remaining mileage is too low.

- When the reminding feature is activated, it will automatically switch to the remaining mileage screen during startup, if remaining mileage is too low.



- Hold the **button for 3 seconds** to switch to inform feature switch.



NOTE It will not display if it's not supported by the engine computer.

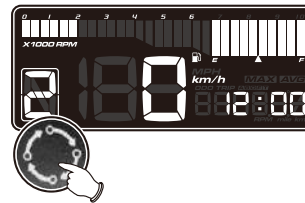

- In the clock screen, press the **button once** to switch to the engine temperature screen.

NOTE Display can be switched off (refer to setting 4-1)

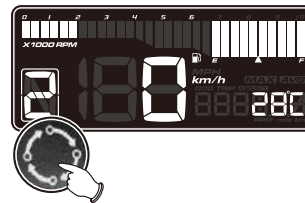

- In the engine temperature screen, press the **button once** to switch to the voltage screen.

NOTE Display can be switched off (refer to setting 4-6-2)

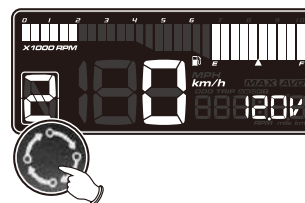

- In the voltage screen, press the **button once** to switch to the tire pressure screen.

NOTE Display can be switch off (refer to setting 4-6-3)

⚠ The screen may be shifted to the tire pressure screen when the vehicle supports TPMS.

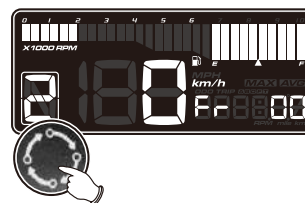

- In the tire pressure screen, press the **button once** to return to the total mileage screen.



4 Setting Screen Switching Description

- Press the **button for 3 seconds** on the main screen to switch to the setting screen.
- Press the **button** to select
- ① Clock ② Unit(Speed/Temperature/tire pressure) ③ Backlight(Mode/Brightness/Color) ④ The tire circumference ⑤ The RPM shift light warning ⑥ Features display ⑦ Mileage maintenance ⑧ Total internal and external mileage

NOTE During setting, if the button is not pressed in 30 seconds, it will automatically return to the startup screen.

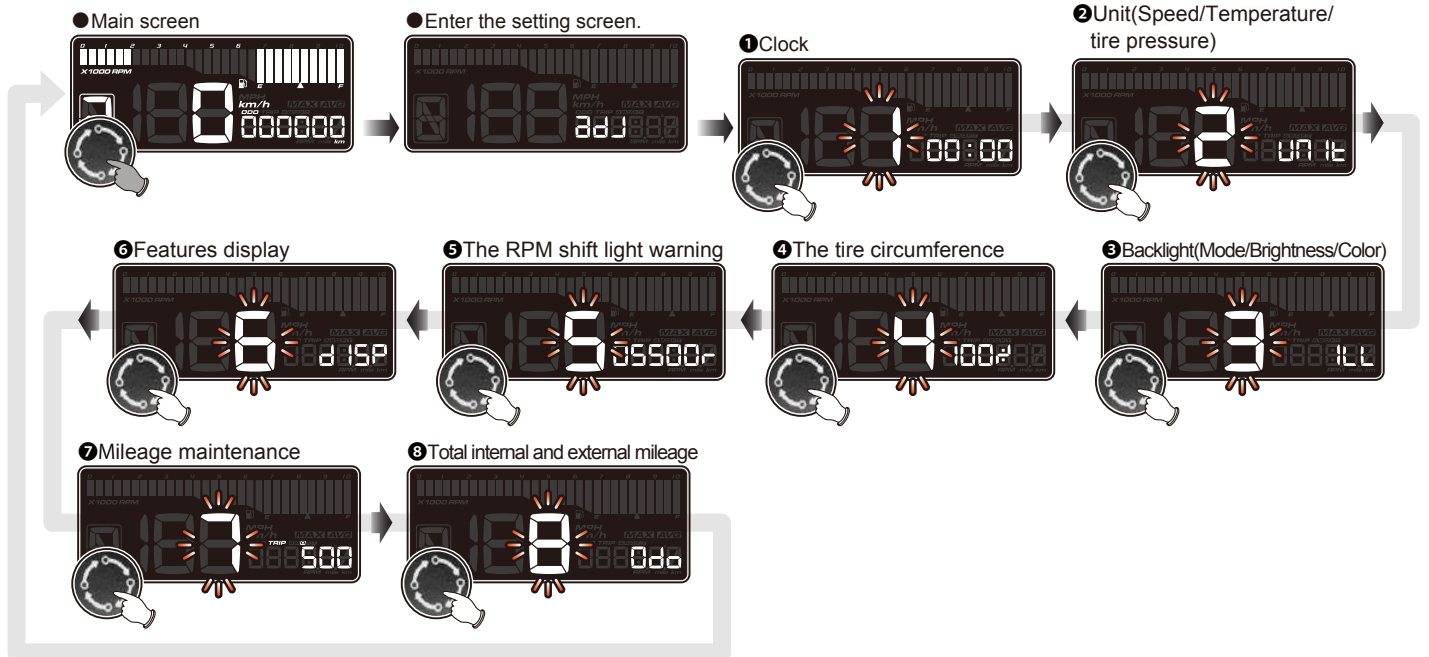

4-1 Clock settings



- In the clock settings screen, hold the **button for 3 seconds** to enter into the setting screen.



- Press the **button once** to select desired setting value.



NOTE Setting range :
Hour : 1~12 (12 h) / 0~23 (24 h)
Minute : 00~59 minutes.
Default value :
Hour : 12(12h)/0(24h).
Minute : 0.



- **Example : If want to set time to 12 hour format.**
- Press the **button once** to select desired setting value.

⚠ Now the setting value will blink.

NOTE Setting range : 12h / 24h
Default value : 24h



- EX : Set time settings from 24 hour format to 12 hour format.
- Hold the **button for 3 seconds** to enter time into the (hour / minute) setting screen.



- **Example : Set time to 01:05 AM.**
- Hold the **button for 3 seconds** to move the cursor to the desired settings level.



⚠ Now the setting value will blink.



- EX : Set time clock setting from 0:00 to 1:05.
- Hold the **button for 3 seconds** to return to the clock settings main screen.



- Clock settings main screen.
- Press the **button once** to enter next setting.

4-2 Speed, temperature, tire pressure unit settings



- In the speed, temperature, tire pressure unit settings main screen, hold the **button for 3 seconds** to enter into the main screen.



- **Example : To set speed unit to MPH(mile).**
- Press the **button once** to select the desired value.

⚠ Now the setting value will blink.
NOTE Setting range : km/h, MPH.
 Default value : km/h.

NOTE Total mileage and distance meter unit will vary according to the speed unit.



- **EX : Set speed unit from km/h to MPH.**
- Hold the **button for 3 seconds** to enter into the temperature unit settings screen.



- **Example : To set the temperature unit to °C.**
- Press the **button once** to select the desired value.

⚠ Now the setting value will blink.
NOTE Setting range : °C(Celsius) and °F(Fahrenheit).
 Default value : °F(Fahrenheit).

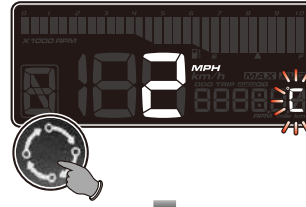

- **EX : Set temperature unit from °F(Fahrenheit) to °C(Celsius).**
 - Hold the **button for 3 seconds** to enter into the tire pressure unit settings screen.
- ⚠ The screen may be shifted to the tire pressure unit setting screen when the vehicle supports TPMS.



- **Example : To set tire pressure unit to BAR.**
- Press the **button once** to select the desired value.

⚠ Now the setting value will blink.
NOTE Setting range : PSI, BAR and KPA.
 Default value : PSI



- **EX : Set tire pressure unit from PSI to BAR.**
- Hold the **button for 3 seconds** to return to the speed, temperature and tire pressure unit settings main screen.

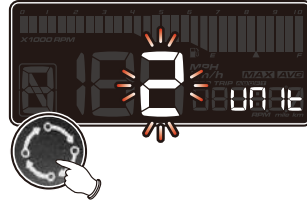

- Speed, temperature and tire pressure unit settings main screen.
- Press the **button once** to enter next setting.

4-3 Backlight brightness settings (Mode/ Brightness/ Color)



- In the backlight (mode /color / brightness) settings main screen, hold the **button for 3 seconds** to enter into the settings screen.



- **Example : To set the mode to Night mode.**
- Press the **button once** to select the desired value.

⚠ Now the setting value will blink.
NOTE Setting Auto(automatically switches according to the light : day mode display for a bright environment and Night mode display for a dark environment), Day mode, Night mode.
 Default value : Auto.



- **EX : Set background from Auto mode to Night mode.**
- Hold the **button for 3 seconds** to enter the backlight color(day) setting.



- **Example : To set backlight color(day) to blue.**
- Press the **button once** to choose the color .

⚠ Now the setting value will blink.
NOTE Setting range : White, Red, Orange, Yellow, Green, Blue, Indigo, Purple.
 Default value : White.

NOTE The backlight color will change immediately after you set the value.



- **EX : Set backlight color(day) from white to blue.**
- Hold the **button for 3 seconds** to enter the backlight brightness(day) setting.

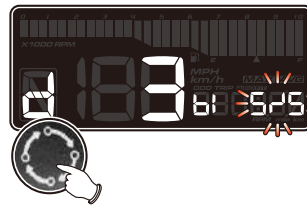

- **Example : To set the backlight brightness (day) to 4/5 (80%).**
- Press the **button once** to select the desired value.

⚠ Now the setting value will blink.
NOTE Setting range : 3/5~ 5/5 (Brightest), 3 different levels available.
 Setting unit : 20% per level.
 Default value : 5/5(100%).

NOTE The backlight brightness will change immediately after you set the value.



- EX : The backlight brightness (day) setting is changed from 5/5 (100%) to 4/5 (80%).
- Hold the **button for 3 seconds** to enter the backlight color (night) setting.



- Example : To set backlight color(night) to Yellow.
- Press the **button once** to choose the color .

⚠ Now the setting value will blink.

NOTE Settings range : White, Red, Orange, Yellow, Green, Blue, Indigo, Purple.
Default value : White.

NOTE The backlight color will change immediately after you set the value.



- EX : Set backlight color(night) from White to Yellow.
- Hold the **button for 3 seconds** to enter the backlight brightness(night) setting.

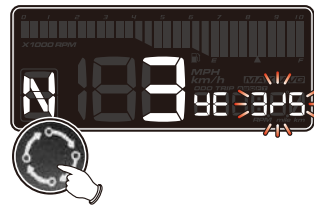

- Example : To set the backlight brightness (night) to 2/5 (40%).
- Press the **button once** to select the desired value.

⚠ Now the setting value will blink.

NOTE Setting range : 1/5(Darkest)~ 5/5 (Brightest), 5 different levels available.
Setting unit : 20% per level.
Default value : 3/5(60%).

NOTE The backlight brightness will change immediately after you set the value.



- EX : The backlight brightness (night) setting is changed from 3/5 (60%) to 2/5 (40%).
- Hold the **button for 3 seconds** to return to the backlight (Mode/ Brightness/Color) settings main screen.

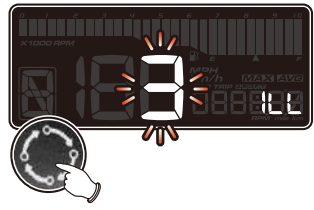

- Backlight (Mode/ Brightness/ Color) settings main screen.
- Press the **button once** to enter next setting.

4-4 The tire circumference settings



- In the tire circumference setting, hold the **button for 3 seconds** to enter into the setting screen.



- Example : Set tire percentage from 100% to 105%.
- Hold the **button for 3 seconds** to return to the tire circumference main screen.



- Example : To set the tire circumference to 105%.
- Hold the **button for 3 seconds** to move the cursor to the desired settings level.



⚠ Now the setting value will blink.

- Press the **button once** to select the desired value.



NOTE Setting range : 50 ~ 210%.
Default value : 100%.

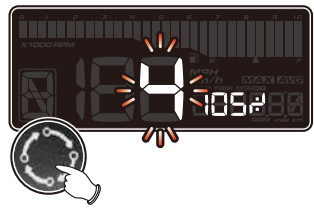

- Tire percentage settings main screen.
- Press the **button once** to enter next setting.

4-5 The RPM shift light warning settings



- In the RPM shift light warning settings main screen, hold the **button for 3 seconds** to enter into the main screen.



- Press the **button once** to select desired setting value.



NOTE Setting range : 2,000 ~ 10,000 RPM.
Default value : 5,500 RPM.



- Example : To set shift light warning value to 5,700 r.
- Hold the **button for 3 seconds** to move the cursor to the desired settings level.



⚠ Now the setting value will blink.



- EX : Set shift light warning value from 5,500 r to 5,700 r.
- Hold the **button for 3 seconds** to return to the RPM shift light warning settings screen.

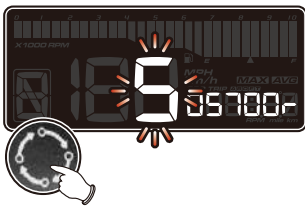

- The RPM shift light warning settings main screen.
- Press the **button once** to enter next setting.

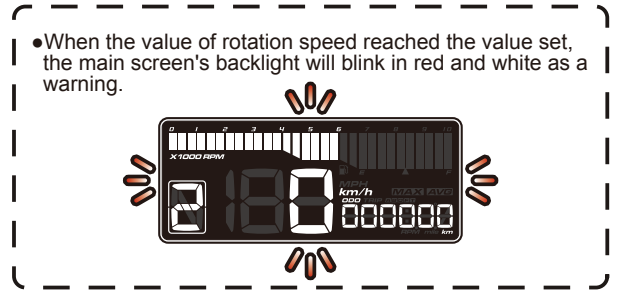

- When the value of rotation speed reached the value set, the main screen's backlight will blink in red and white as a warning.

4-6 Features display settings



- In the display settings main screen, hold the **button for 3 seconds** to enter into the sub settings screen.

4-6-1



- In Trip B display settings main screen, hold the **button for 3 seconds** to enter into the settings screen.



- **Example : To hide (H) trip B display.**
- Press the **button once** to select the desired value.

⚠ Now the setting value will blink.
NOTE Setting range : Hidden (H), Show (S).
 Default value : Show (S).



- **EX :** Set type B display from show (S) to hidden (H).
- Hold the **button for 3 seconds** to return to the trip B display settings main screen.



- Trip B display settings main screen, hold the **button for 3 seconds** to enter into the engine temperature display settings main screen.

4-6-2



- In the engine temperature display settings main screen, hold the **button for 3 seconds** to enter into the settings screen.



- **Example : To hide (H) the engine temperature display.**
- Press the **button once** to select the desired value.

⚠ Now the setting value will blink.
NOTE Setting range : Hidden (H), Show (S).
 Default value : Show (S).



- **EX :** Set engine temperature display from show (S) to hidden (H).
- Hold the **button for 3 seconds** to return to the engine temperature display settings main screen.



- Engine temperature display settings main screen.
- Press the **button once** to enter into the voltage display settings main screen.

4-6-3



- In the voltage display settings main screen, hold the **button for 3 seconds** to enter into the settings screen.



- **Example : To hide (H) voltage display.**
- Press the **button once** to select the desired value.

⚠ Now the setting value will blink.

NOTE Setting range : Hidden (H), Show (S).
 Default value : Show (S).



- **EX :** Set voltage display from show (S) to hidden (H).
- Hold the **button for 3 seconds** to return to the voltage display settings main screen.



- Voltage display settings main screen.
- Press the **button once** to enter into the feature display settings main screen.

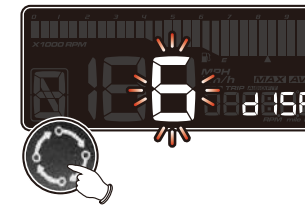

- In the features display settings main screen.
- Press the **button once** to enter next setting.

4-7 Mileage maintenance settings

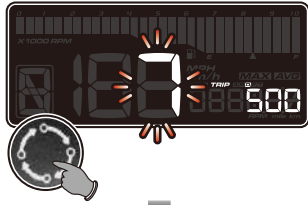

- In the mileage maintenance main screen, hold the **button for 3 seconds** to enter into the sub settings screen.

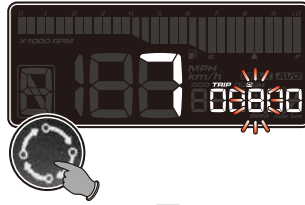

- EX : Set the mileage maintenance from 500 to 800.
- Hold the **button for 3 seconds** to return to mileage maintenance main screen.



- **Example : To set mileage maintenance to (ON).**

- Press the **button once** to select the desired settings value.

⚠ Now the setting value will blink.

NOTE Display range : ON, OFF.
Default value : OFF.

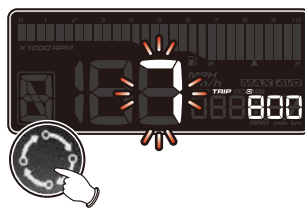

- Mileage maintenance settings main screen.
- Press the **button once** to enter into the next settings screen.



- EX : Set mileage maintenance from OFF to ON.
- Hold the **button for 3 seconds** to enter into the mileage maintenance main screen.

NOTE When set to OFF, it will directly return to mileage maintenance main screen.



- **Example : To set mileage maintenance value to 800.**

- Hold the **button for 3 seconds** to move the cursor to the desired settings level.



⚠ Now the setting value will blink.

- Press the **button once** to select desired setting value.



NOTE Setting range : 500 ~ 16,000 km
(300 ~ 10,000 mile).
Default value : 500 km(300 mile).

4-8 Total internal and external mileage settings



- In the total mileage settings main screen, hold the **button for 3 seconds** to enter into the sub settings screen.



- Loading screen for the total external mileage, press and hold the **button for 3 seconds** to load the current vehicle mileage once.

4-8-1



- **Example : Current total internal mileage display is 5 km.**
- Press the **button once** to enter into the total external mileage settings screen.

⚠ User unable to adjust or remove total internal mileage.

NOTE Display range : 0 ~ 999,999 km (mile).



- **Example : To set external total distance value to 50,000 km.**

- Hold the **button for 3 seconds** to move the cursor to the desired settings level.



⚠ Now the setting value will blink.

- Press the **button once** to select desired setting value.



NOTE Setting range : 0 ~ 999,999 km (mile).

4-8-2



- In the total external mileage settings main screen, hold the **button for 3 seconds** to enter into the loading screen for the total external mileage.



- EX : Set the total external mileage from 0 to 50,000 km.
- Hold the **button for 3 seconds** to return to the total external mileage settings main screen.

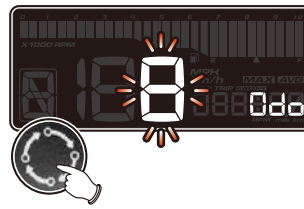

- Total mileage settings main screen.
- Press the **button once** to return to startup screen.



- Total external mileage settings main screen.
- Press the **button once** to return to total mileage settings main screen.

5 Trouble shooting

The following situation does not indicate malfunction of the meter. Check the following points, before taking it in for repairs.

Trouble	Check item	Trouble	Check item
The meter doesn't work when the power is on.	<ul style="list-style-type: none"> ●The power isn't supplied to the meter. →Make sure the wiring is connected. The wiring and fuse are not broken. →The battery is too old to supply needed power (DC 12 V). 	Speed is inaccurate.	<ul style="list-style-type: none"> ●May be wrong settings. →Check the settings menu to confirm whether the setting for speed is correct.
The meter shows wrong information.	<ul style="list-style-type: none"> ●Check the voltage of your battery, and make sure the voltage is over DC 12 V. 	The clock is incorrect.	<ul style="list-style-type: none"> ●May be wrong setting. →Check the setting list to see whether the setting for clock is correct.

※ If the problems still can't be solved, contact our technical department for assistance.