



Thank you for purchasing **KOSO DL Thermometer**, before operating the unit, please read the instruction thoroughly and retain it for the future reference.

Notice

1. The lcd meter is apply for **DC 12V**.
2. For installation, please follow the steps described in manual. Any damage caused by wrong installation shall be imputed to the users.
3. To avoid the short circuit, please don't pull the wire when installing. Don't break or modify the wire terminal.
4. Do not disassemble or change any parts excluding the manual description.
5. The interior examination or maintenance should be executed by our professionals.

SYMBOL NOTE:

NOTE You could get the installation details from the information behind the mark.

△ Some processes must be followed to avoid the affection caused by wrong installation.

▲WARNING! Some processes must be followed to avoid damages to yourself or the public.

▲CAUTION! Some processes must be followed to avoid the damage to the vehicle.











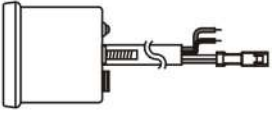

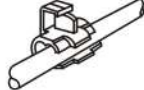

PRESS THE
BUTTON ONE TIME





HOLD PRESS
THE BUTTON
3 SECONDS

1-1 Accessory

<p>1 LCD meter X1</p> 	<p>2 Temp. sensor extension wire X1</p> 	<p>3 Temp. Sensor</p> 	<p>4 Connect terminal X2</p> 
<p>5 Meter bracket X 1</p> 	<p>6 Handle bar clamp X 1</p> 	<p>7 Rubber X 1</p> 	<p>8 M6 X 18L screw X 1</p> 
<p>9 M4 X P0.7 nut X 2</p> 	<p>10 M6 X P1.0 nut X1</p> 	<p>11 M4 washer X 2</p> 	<p>12 M6 washer X 1</p> 
<p>13 Aluminum bush X 1</p> 			

NOTE Please contact the local distributor if the items you open are not the same, with the above-listed one.

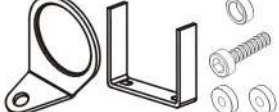
1-2 Option accessory

<p>1 U-type meter bracket</p> 	<p>2 Mirror hole meter bracket</p> 	<p>3 Universal adhesive bracket</p> 
--	---	---

NOTE Some of the option accessories may not sell. For the details, please contact the local distributor.

2-1 Wiring installation instructions

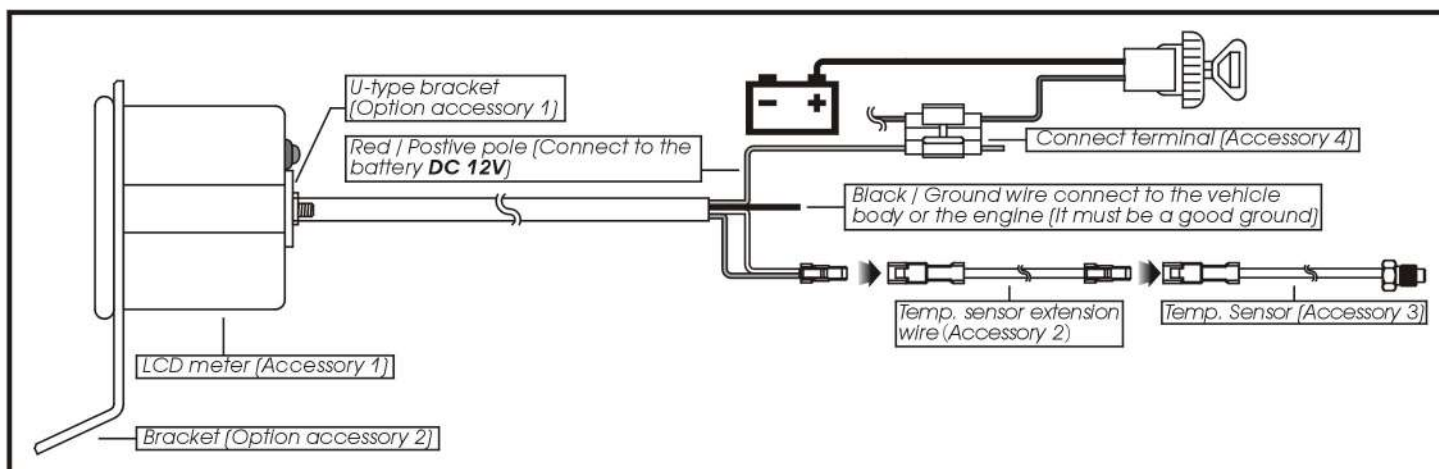

2-2 Installation instructions

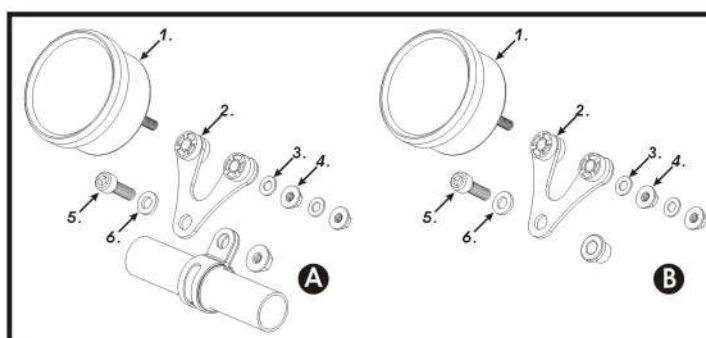

When installing, please follow the process.

1. LCD meter (Accessory 1)
 2. Meter bracket (Accessory 5)
 3. M4 washer X2 (Accessory 11)
 4. M4 X P0.7 nut X2 (Accessory 9)
 5. M6 X18L screw (Accessory 8)
 6. M6 washer (Accessory 12)
- A** Use the meter bracket (Accessory 5), handle bar clamp (Accessory 6), rubber (Accessory 7) and the nut to install the meter on the handle bar.
- B** Use the aluminum bush (Accessory 13) to install the meter on the handle bar stem.

3-1 Display instruction

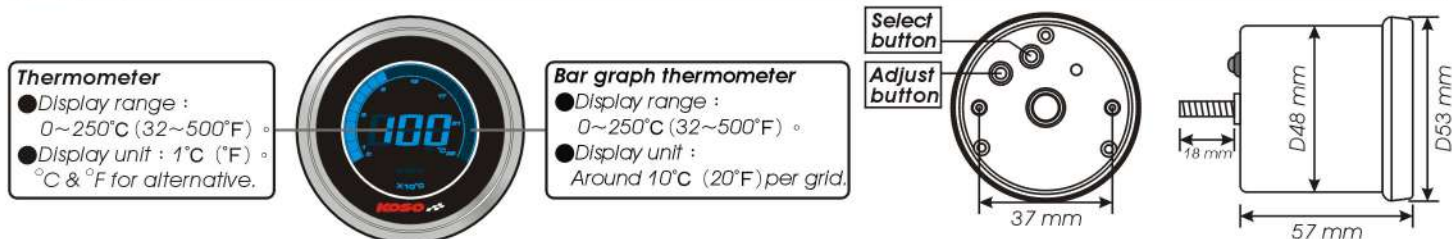

3-2 Function, setting instruction

● Thermometer	Display range : 0~250°C (32~500°F) Display unit : 1°C (°F) for alternative	● Effective voltage	DC12V
○ Bar graph thermometer	Display range : 0~250°C (32~500°F) Display unit : 10°C (20°F) per grid.	● Effective temperature range	-10~+60°C
○ Temperature alarm	Setting range : 60~250°C (140~482°F) Setting unit : 1°C (°F)	● Meter standard	JIS D 0203 S2
		● Meter size	D48 X 52.8 mm
		● Meter weight	Around 117 g

NOTE Design and specification are subject to change without notice!

4-1 The button function instruction

4-1 Adjust button function instruction



- Hold pressing the **Adjust button** for 3 seconds to switch the temperature unit from °C to °F.



4-2 Adjust + Select button function instruction X3



- Hold pressing the **Adjust & Select button** for 3 seconds to enter setting screen. (Check section 4-2 for detail)



4-2 Function setting instruction



- In main screen, Hold pressing the **Select & Adjust for 3 seconds** to enter the temperature warning setting.



- The main screen.



- EX: You want to set the temperature warning at 95°C.
- Press the **Adjust button** to move to the digit you want to set.



NOTE Setting range: 60~250°C
(140~482°F)

⚠ The digit you could set is flashing now.

- Press the **Select** button to change the value.



- EX: The temperature alarm setting is changed from 90°C to 95°C.
- Press **Adjust button** to back the main screen.

5-1 Trouble shooting

The following situation do not indicate malfunction of the meter. Please check the following before taking it in for repair.

Trouble	Check item	Trouble	Check item
The meter doesn't work when the power is on.	<ul style="list-style-type: none"> ● The power doesn't supply to the meter. <ul style="list-style-type: none"> → Please make sure the wiring is connected. The wiring and fuse are not broken. → The battery is broken or the battery is too old to supply enough power (DC 6V) to make the meter work. 	Temp does not appear or appear incorrectly.	<ul style="list-style-type: none"> ● Please check the sensor. <ul style="list-style-type: none"> → Does the wiring break or falling off?
The meter shows wrong information.	<ul style="list-style-type: none"> ● Please check the voltage of your battery, and make sure the voltage is over DC 6V. 		

※ If still can't solve the problems according to the steps above, please contact with distributors or us.